

JS-C33 general purpose programmable battery power display

SUMMARY:

This product is a universal instrument, the color LCD screen, with low power consumption, long time switch, can display the battery voltage, temperature value (Selective assembly), alarm (Selective assembly) can be used in a variety of lighting conditions. The default parameters for lithium batteries, lead-acid batteries, lithium iron phosphate battery, Ni MH battery application field; through the development of programming, can be applied to any battery, simple wiring, convenient maintenance and disassembly using standard connector.

IMPORT FEATURES:

- The patented product, neutral packaging production, with simple dustproof waterproof surface, with full protection cover.
- The color liquid crystal material, light clear display, display the soft night.
- To customize the type of battery, suitable for lead-acid, lithium-ion batteries, lithium iron phosphate, metal hydride battery.
- To display the percentage of remaining battery power,voltage, temperature value.
- The 10~100V wide input voltage,reverse protection.
- The product can go to sleep after 10 seconds.
- The low power red mark flashes to remind.
- The installation is simple, with a buckle, without screws.
- **The buzzer alarm(Selective assembly).**
- **detection of the battery temperature (Selective assembly).**
- **The open programming mode**

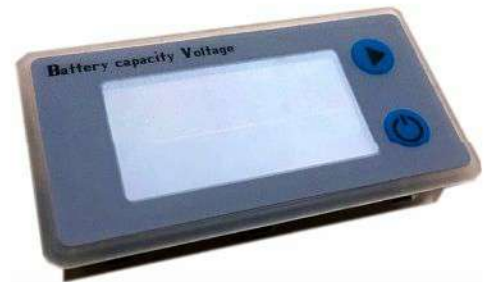

PARAMETER:

parameter	Min	Typical	Max	Unit	Figure
Product size				mm	61.5*33.5*13.5
Installation size				mm	58.5*28.5
Display size				mm	36*19.5
Weight	20	21	22	g	
Working voltage	10		100	V	Common
Working voltage	8		50	V	Special
Power waste		5	6	mA	LED ON
Voltage accuracy		±0.1	±0.5	%	
Temperature accuracy		±0.5	±1	°C	Selective assembly
Sleep power	6	10	12	uA	20V
Beep volume	70	75	80	db	Selective assembly
Working temperature	-10	25	55	°C	

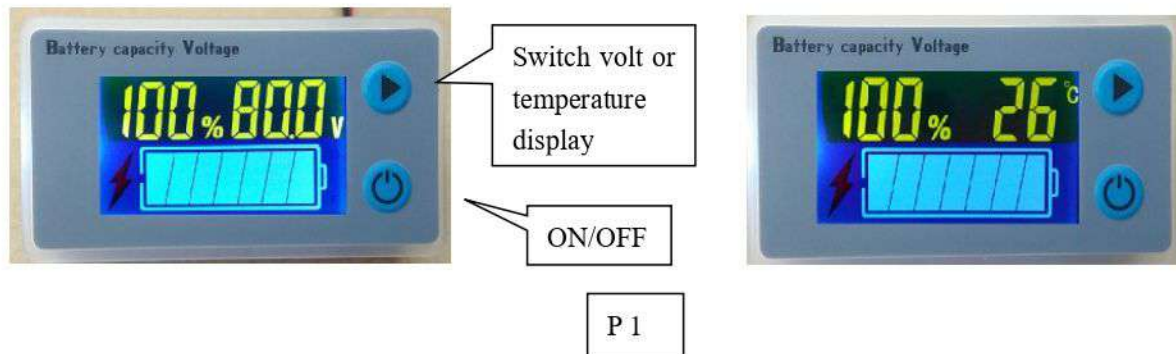

The color of the photo is chromatic aberration, for reference only

INSTRUCTIONS:

1. PH2.0 terminal products supporting the use of wire, connected to the circuit board face should plug back.
2. External NTC temperature sensor, please put the sensor to measure the temperature of the parts, do not squeeze the sensor(selective assembly).
3. Red line to the positive terminal, black line to the negative terminal.
4. After the instrument is powered on , which shows the percentage of the battery power, the voltage value, and the symbols of the analog battery.
5. Press the button to turn off the instrument. In close mode, you can wake up the instrument by pressing any button.
6. Click the button, you can switch the voltage value and temperature value display.
7. The battery symbols on the display interface, from the right to the left, are 7 display boxes representing the pool power from low to high.
8. The voltage on the display interface is measured in real time, and the voltage value is displayed on 10-100V.
9. The percentage on the display interface is the percentage of the remaining battery power
10. When the battery is connected to the charger or the discharge of the high current load, the display parameters will fluctuate
11. The red lightning flashes the alarm when the battery is low
12. Low voltage buzzer alarm (Selective assembly)
13. If the battery specification is special, you can enter the set mode 3-- and reset the upper and lower limits of the measured battery voltage.

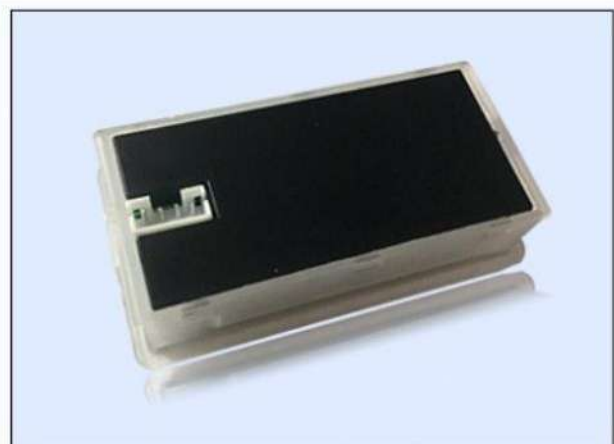

Go into settings mode:

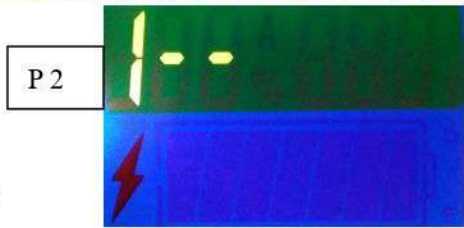

1. Turn on the machine, press the button for 5 seconds, enter the main menu, as shown in Figure P 2.
2. The main menu has 5 sub menus:1--, 2--, 3--, 4--, 5--.
3. Press the button , and the 5 submenu loops.
4. Each function of the 5 sub menu:
 - 1- -: Select lithium battery or lead acid Battery or LiFeCoPO4 Battery
 - 2- -: Setting Delay Time Delay OFF/ON,and select Delay Time
 - 3- -: The voltage of percentage 0 to 100 could be customized.
 - 4- -: Buzzer switch and alarm value setting.11.5V-40V.
 - 5- -: Calibrate the instrument voltage again.
5. Click the button , select the menu to enter, and hold the button for a little long time to quit.
6. All parameters must be saved at the last time.

Detailed Submenu function:

1- -: Quick change battery type

Under this menu, you can change the default parameters quickly, The L represents the lithium battery, and the latter figure is the series quantity of the lithium battery, P stands for lead-acid batteries, and the numbers behind represent voltage.

Set step: Enter the menu 1--, as shown in P 3, and display 1—L/P/F xx. Click the button to switch between F, P, and L. Press the button to change the parameters, select the appropriate battery specifications.After selection, press the button to save it. If you don't need to change other parameters, hold the button for a little long time to quit.

For example: L3 represents 3 string lithium $4.2V \times 3S = 12.6V$
 L4 represents 4 string lithium $4.2V \times 4S = 16.8V$
 F4 represents 4 string LiFeCoPO4 $3.2V \times 4S = 12.8V$
 F8 represents 8 string LiFeCoPO4 $3.2V \times 8S = 25.6V$
 P12V stands for lead-acid 12V batteries
 P24V stands for lead-acid 24V batteries

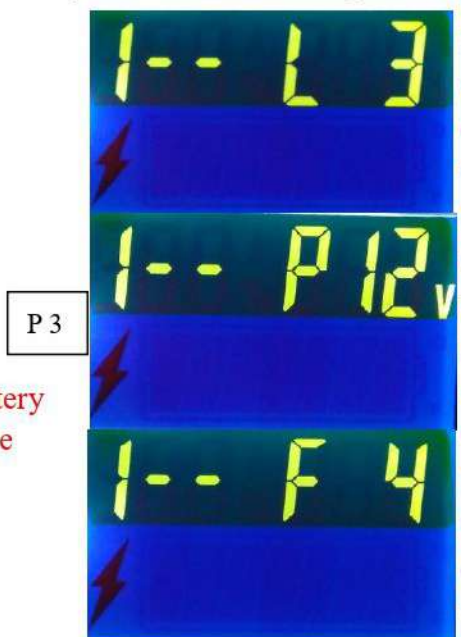



Note: If you choose the battery specifications and the actual battery specifications are different, The percentage value cannot be used as a reference value for the remaining battery power. the voltage value is the current battery voltage.
 All parameters must be saved at the last time.

2- -: setting Delay Time ,Delay ON-OFF

Under this menu, the time delay function and the delay time can be set,as shown in P 4:

Left side display switch status,Right side display the delay time(10/30/60/120 unit:S)

Set step: Enter the menu 2--, Press the button  to change the parameters, select the appropriate battery specifications.After selection, press the button  to save it. If you don't need to change other parameters, press the button  to quit.



P 4

Note: The time delay function works only when it is turned on.
If this function is turned on, the LCD panel will have a 'D' display.

3- -: The voltage of percentage 0 to 100 could be customized





If the battery specification is not conventional, then you can adjust the battery voltage on the upper and lower lines by using the function under this menu.

Enter the menu 3--,as shown in P 5:

1. The value on the left represents the voltage value of 0% .
2. The value on the right represents the voltage value of 100%.



P 5

Set step: Enter the menu 3--, Press the button  to adjust the setting voltage, press the button  to carry, press and hold the button  to save, and if you enter this menu is a mistake, you can press and hold the button  to exit.

Notes: The input value must not exceed the instrument working voltage, If the value on the left side is greater than or equal to the value on the right side, the save is invalid.





4- -: Buzzer alarm value setting and on-off

Enter the menu 4--,as shown in P 6:

1. The left side is the buzzer on-off status.
2. The value on the right is the alarm voltage value.



P 6

Set step: Enter the menu 4--, press the button  to take the buzzer on or off, press the button  to carry, press and hold the button  to save, and if you enter this menu is a mistake, you can press and hold the button  to exit.

Notes: The input 11.5V-40V.value must not exceed the instrument working voltage, When the buzzer works, the red lightning symbol flashes in sync.

5- -: Calibrate the instrument voltage again

P 7



Enter the menu 5--as shown in P 7:

Before entering the calibration interface, please provide an accurate 20V operating voltage for the instrument To prevent misoperation, to enter the menu in 5-- status, press the button  long.

After entering this menu, the meter will be automatically calibrated according to the supplied voltage and cannot be calibrated if the voltage range is not between 19 and 20V.

Notes: please provide an accurate 20V operating voltage for the instrument To ensure correct calibration, When the calibration is complete, the instrument will automatically exit this menu and display the normal working interface.

Outline Dimension

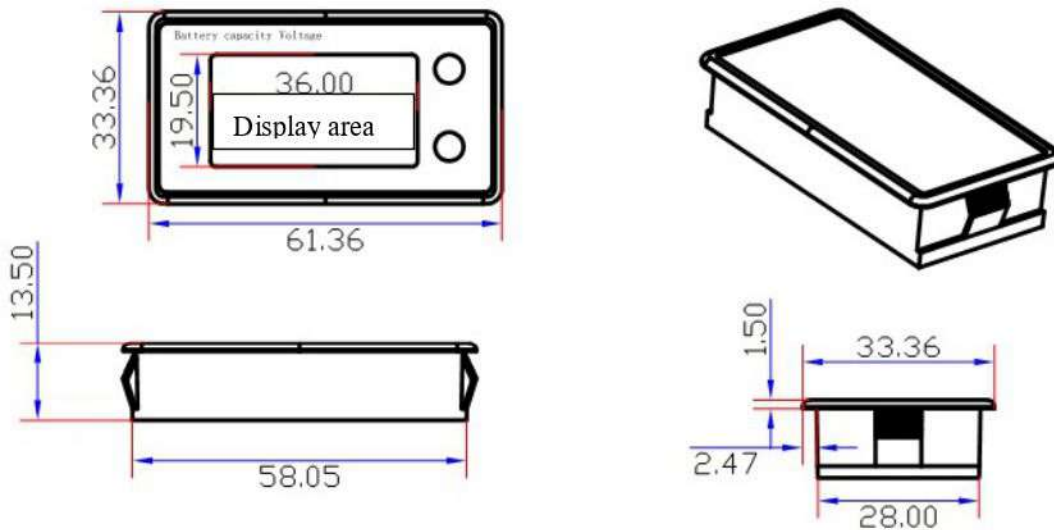

Utlne dimensional drawing: (unit :mm)

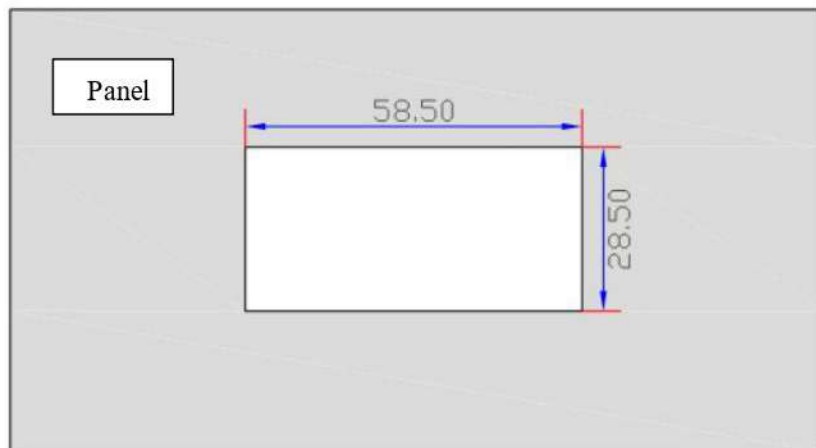

Notes: panel thickness 2-3MM best, Please adjust the slotting size according to the panel material

MODEL CORRESPONDENCE TABLE:

Model	Function
JS-C31	
JS-C31K	
JS-C31H	
JS-C32	
JS-C33	
JS-C11	
JS-C35	
JS-C36	